



UNIVERSITEIT
GENT

Flow cytometric microbial monitoring for safeguarding drinking water quality

Ir. Jorien Favere

Promotors: Prof. Dr. Ir. Nico Boon & Prof. Dr. Ir. Bart De Gusseme

Tutors: Ir. Jasmine Heyse & Peter Rubbens



CMET

Center for Microbial Ecology and Technology

Microbiële hergroei in drinkwater is een probleem



Woonwijk kampt met 'perfect drinkbaar' bruin leidingwater

13/08/2015 om 06:59 door Koen Van Waesberghe - [Print](#) - [Corrigeer](#)



Bron: hln.be

Regio > Zelzate

“Kraantjeswater is hier al jaren bruin”

WATERMAATSCHAPPIJ VERVANGT 14 KILOMETER LEIDINGEN
IN WIJK DE KATTE

Bron: nieuwsblad.be

Flow cytometry is a very promising monitoring technique

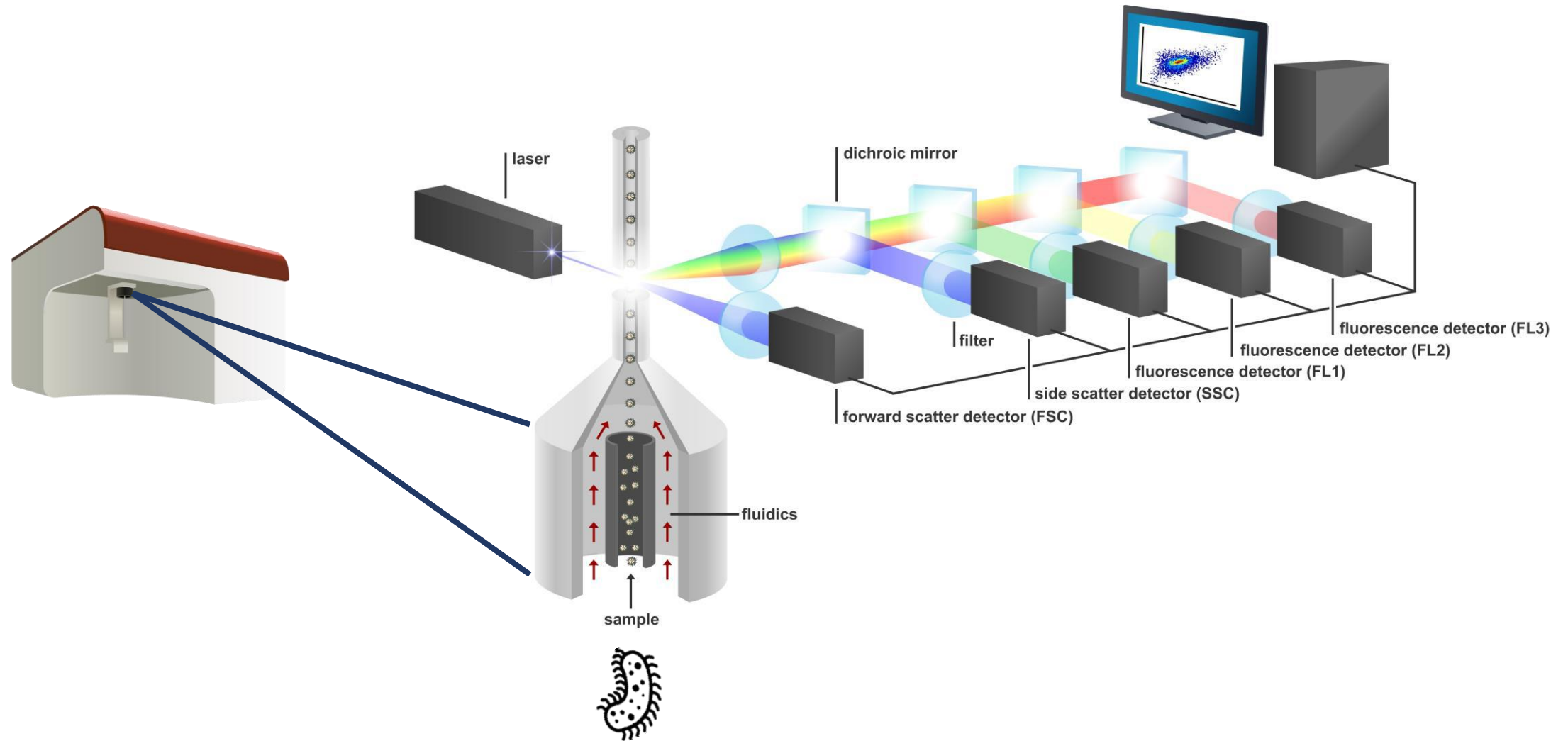

Plaattellingen zijn niet perfect

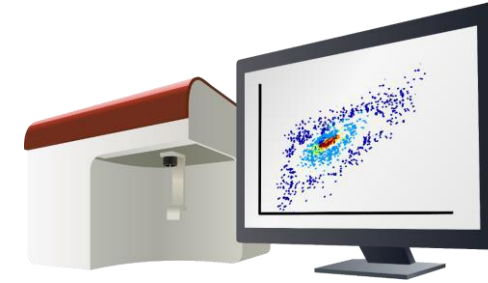
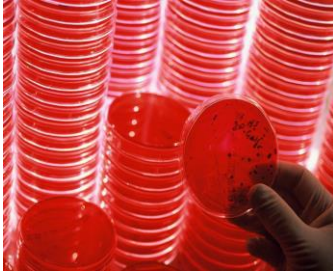

+

Makkelijk en goedkoop
Wetgeving

-

Traag (5-7 dagen)
Arbeidsintensief
Slechts 0,01% van de bacteriën is cultiveerbaar

+

Snel (10 000 cellen/s)
Onafhankelijk van cultivatie
Online en geautomatiseerd (mijn thesis)

-

Big data management (mijn thesis)
Kostprijs instrument

Thesisopzet

Bruin water in uithoeken drinkwaternetwerk

- DC Water, Washington DC (USA)

Hergroei in watertorens

- Pidpa, Antwerpen
- FARYS, Gent



Watertoren FARYS, Kattenberg Gent

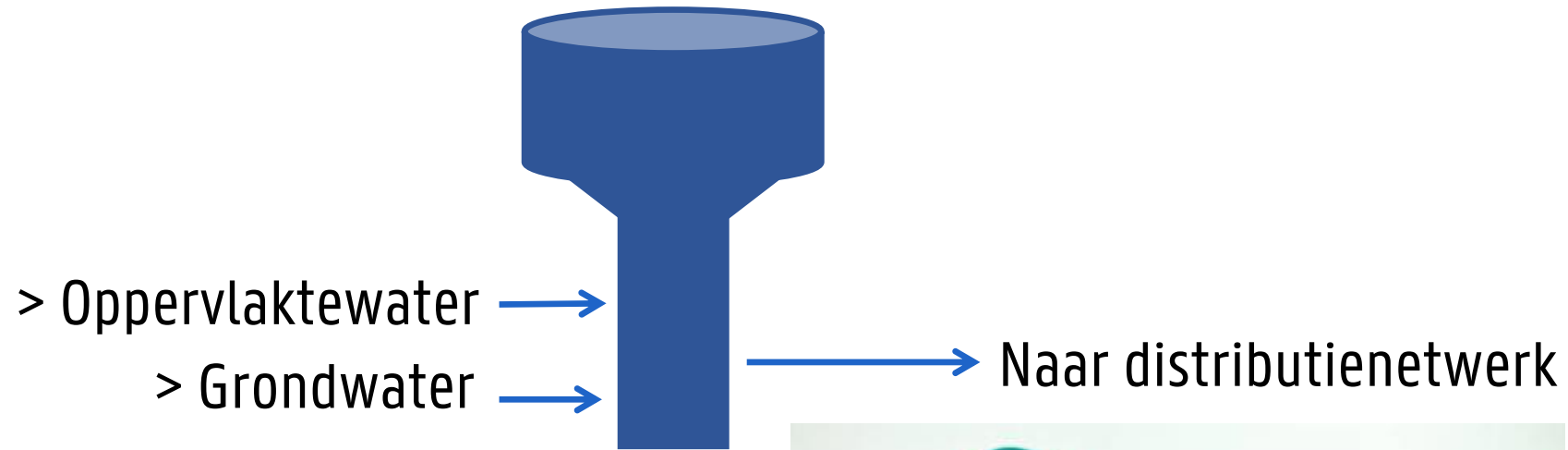

Wekelijks staal

Watertoren FARYS, Kattenberg Gent

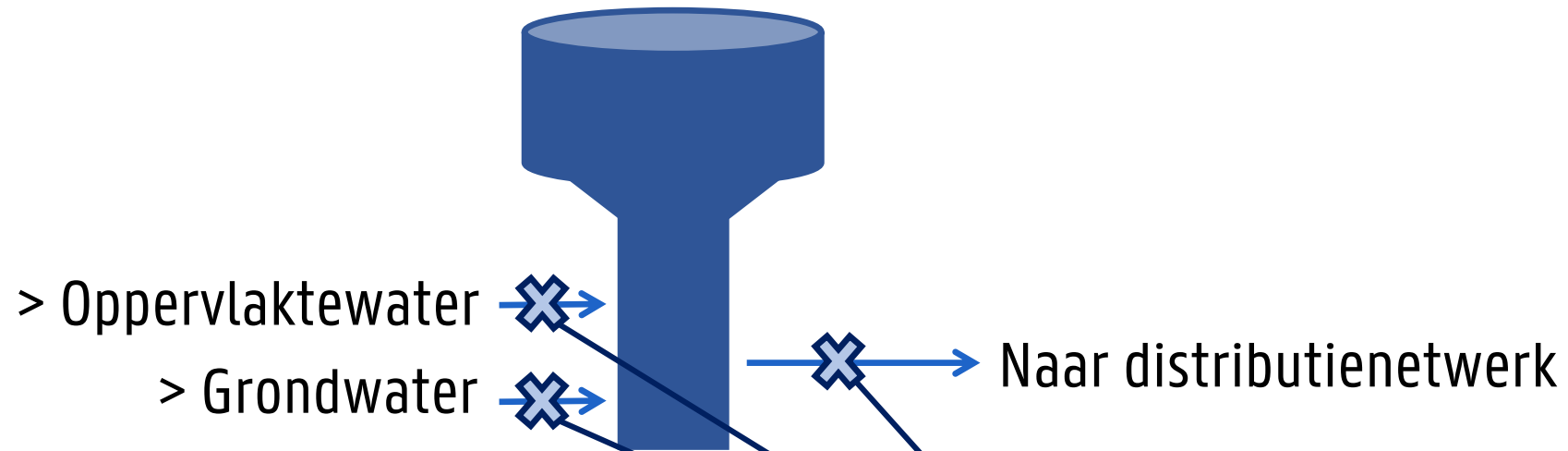

Online metingen



Dynamiek van de microbiële gemeenschap

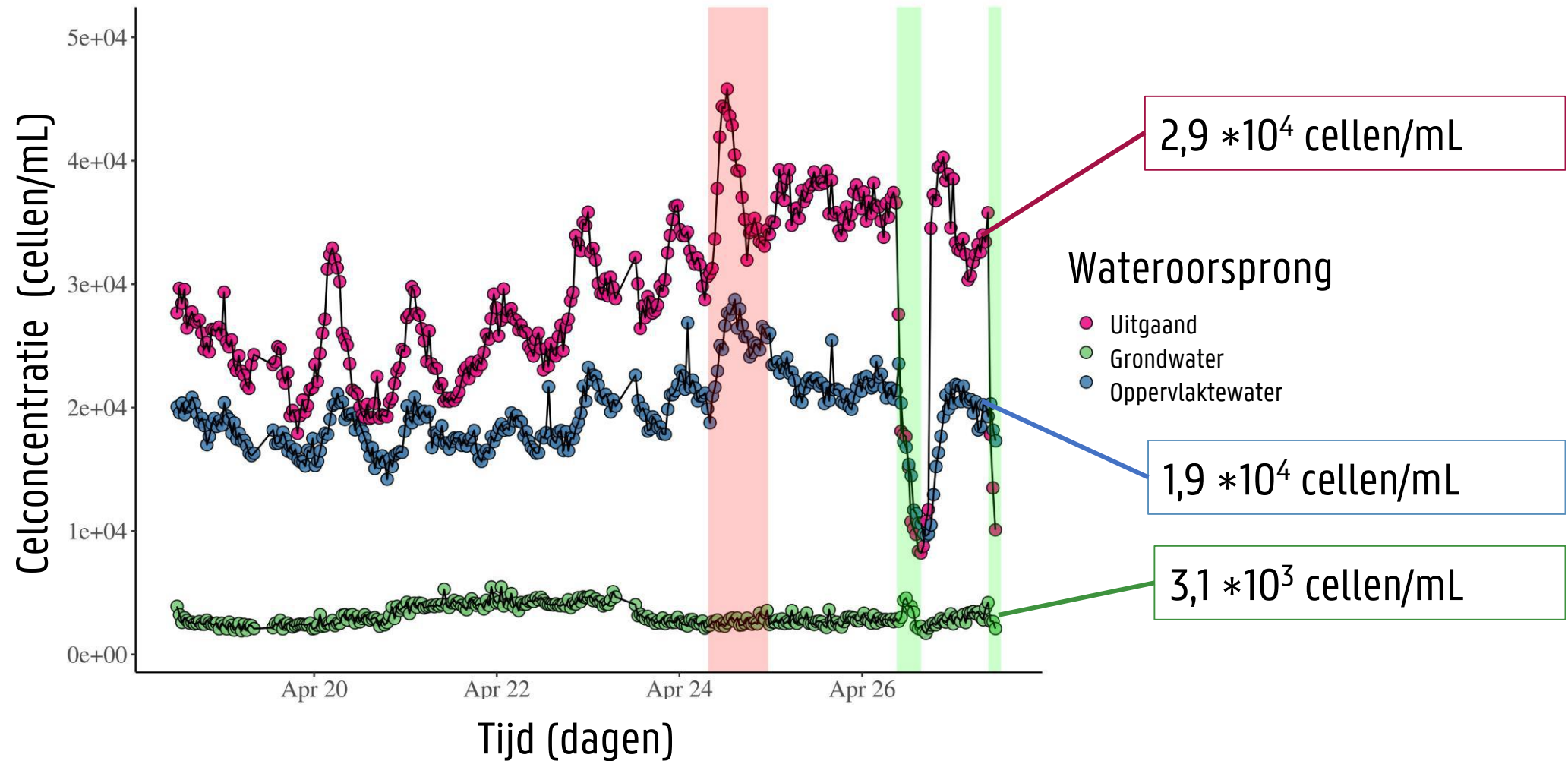

Dynamiek van de microbiële gemeenschap

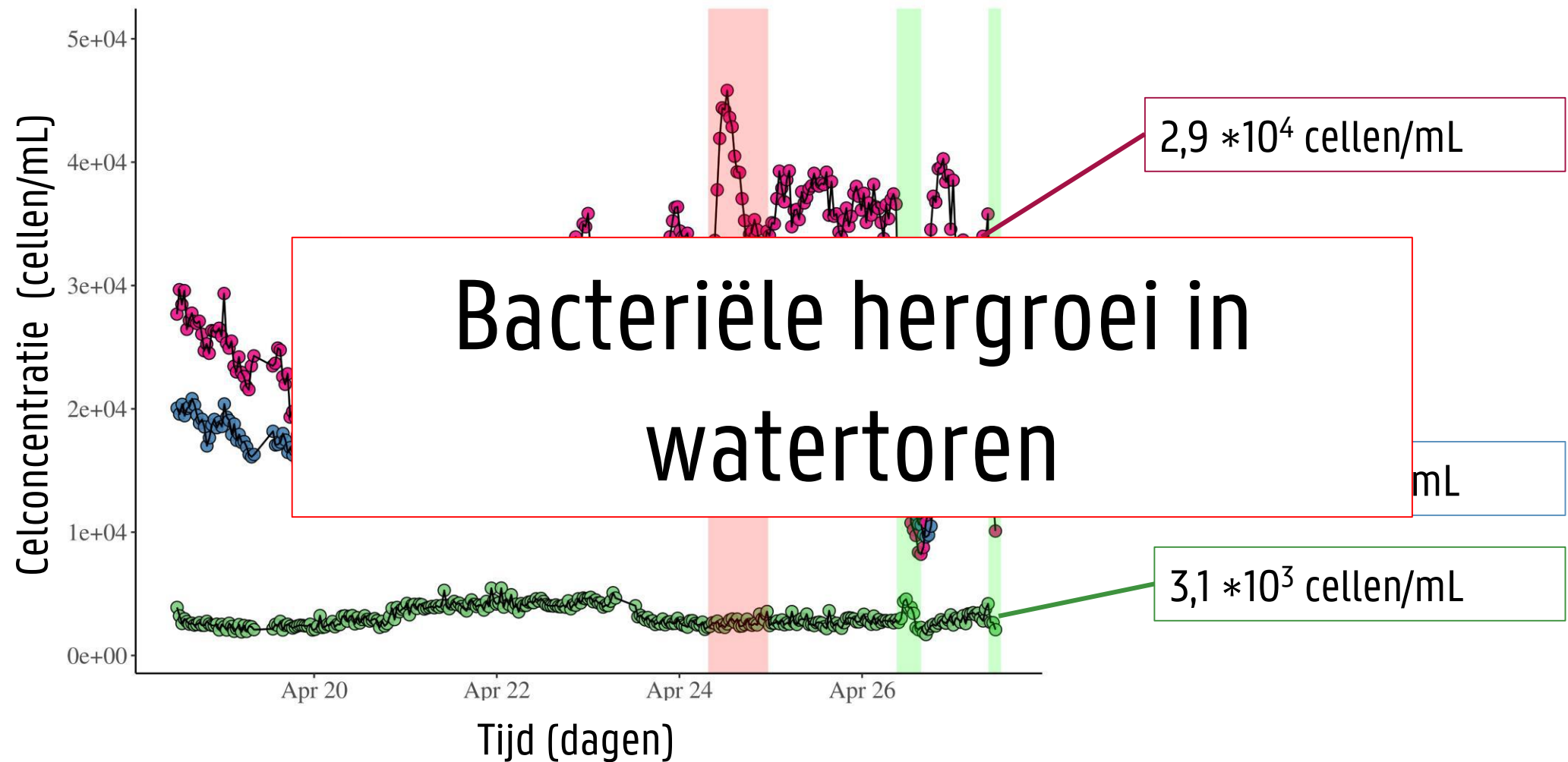

Dynamiek van de microbiële gemeenschap

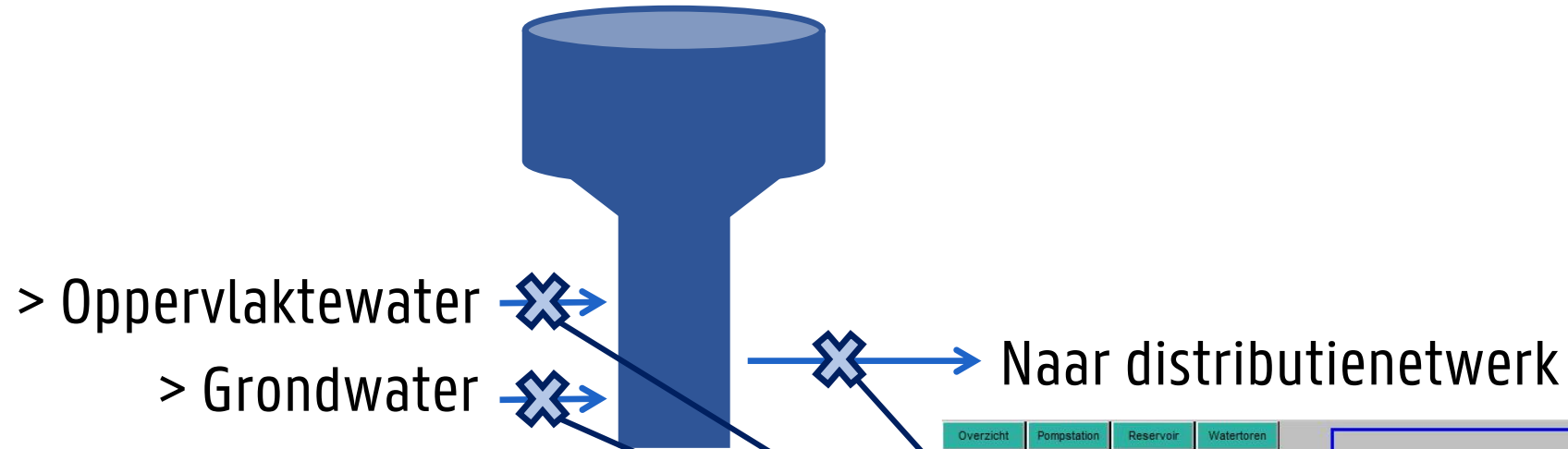

WINCC, FARYS

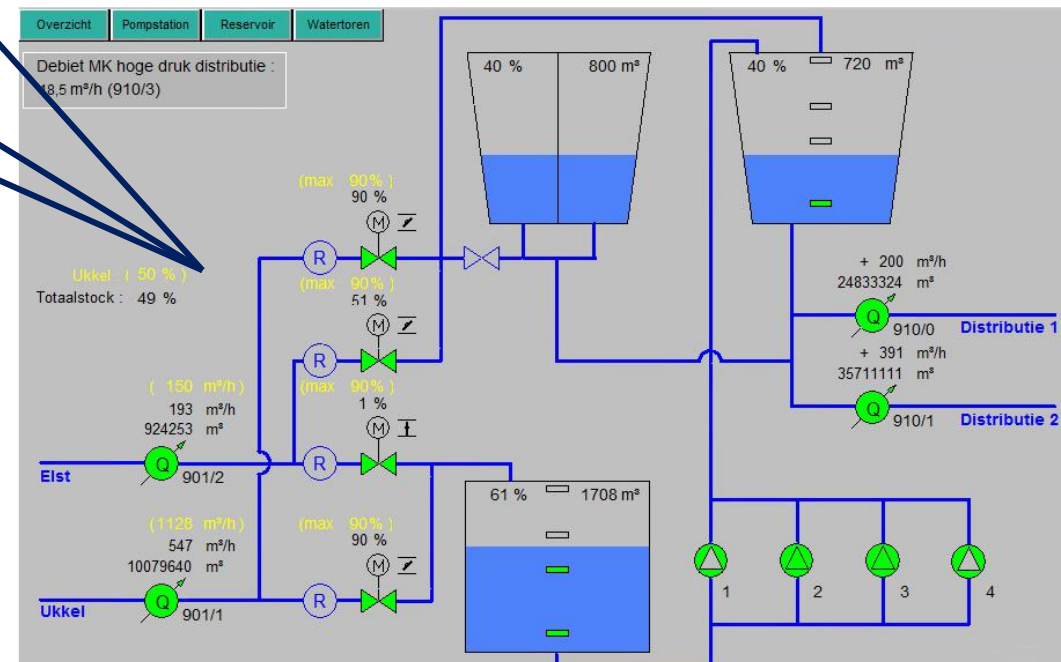

Dynamiek van de microbiële gemeenschap

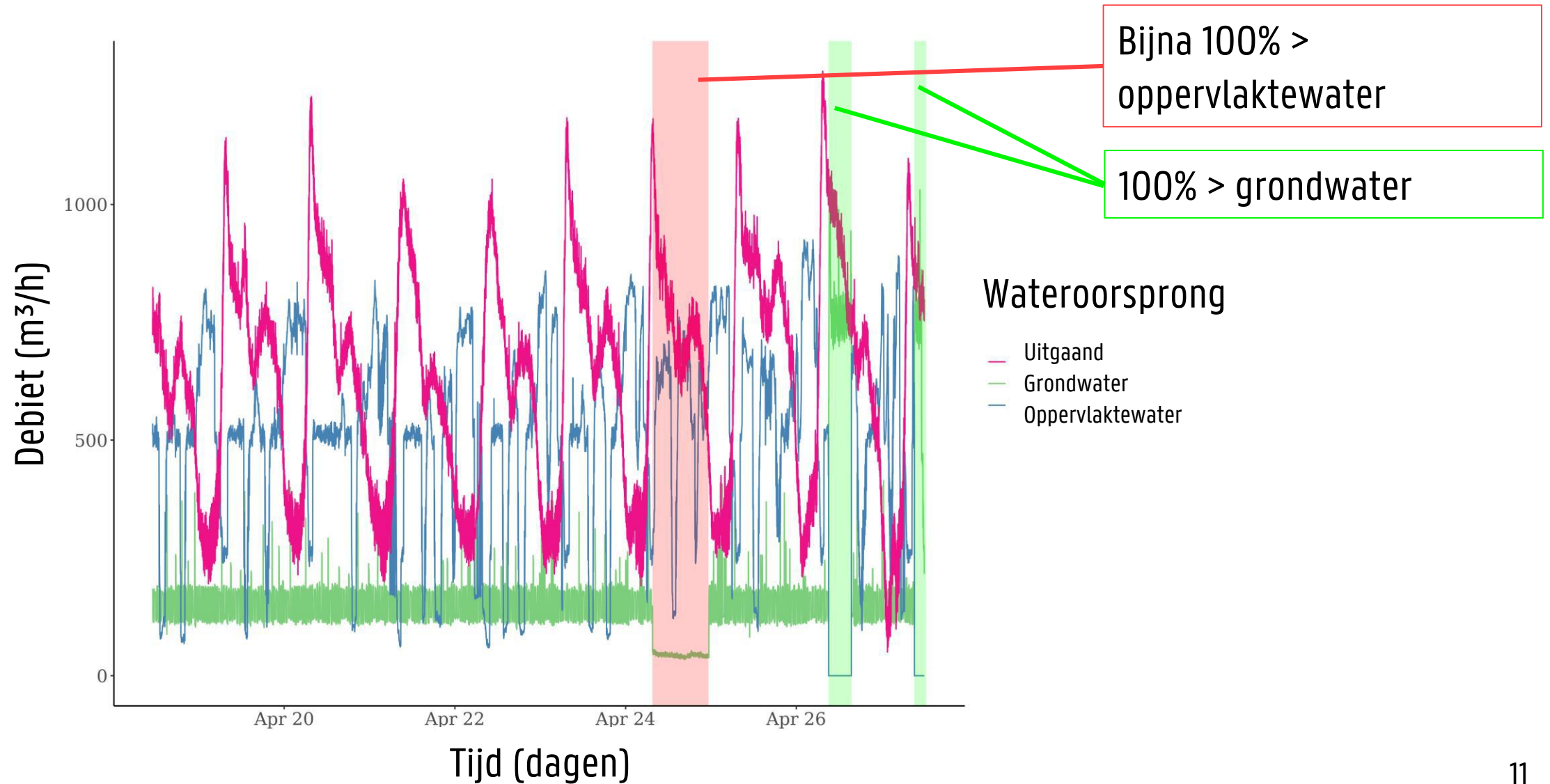

Dynamiek van de microbiële gemeenschap

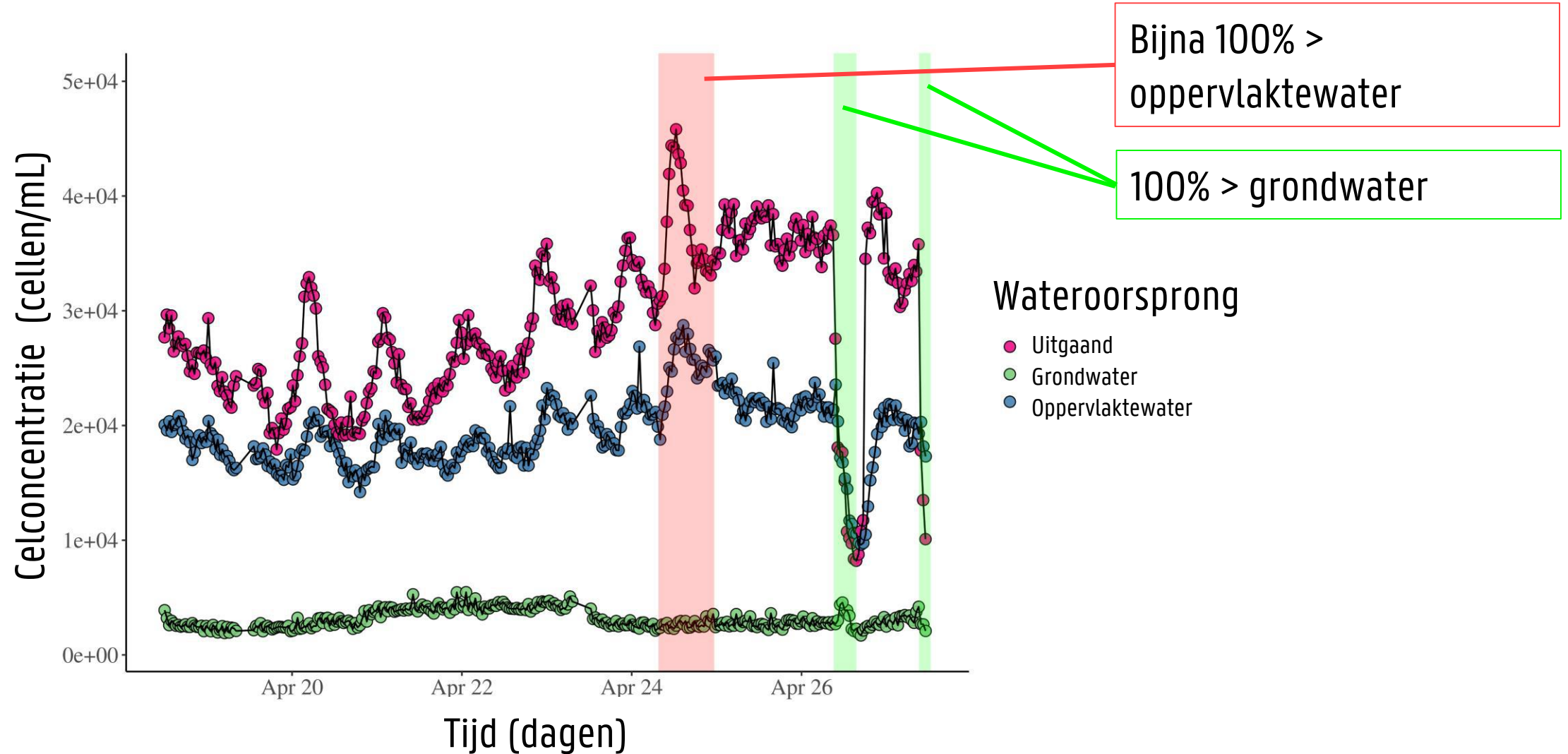

Dynamiek van de microbiële gemeenschap

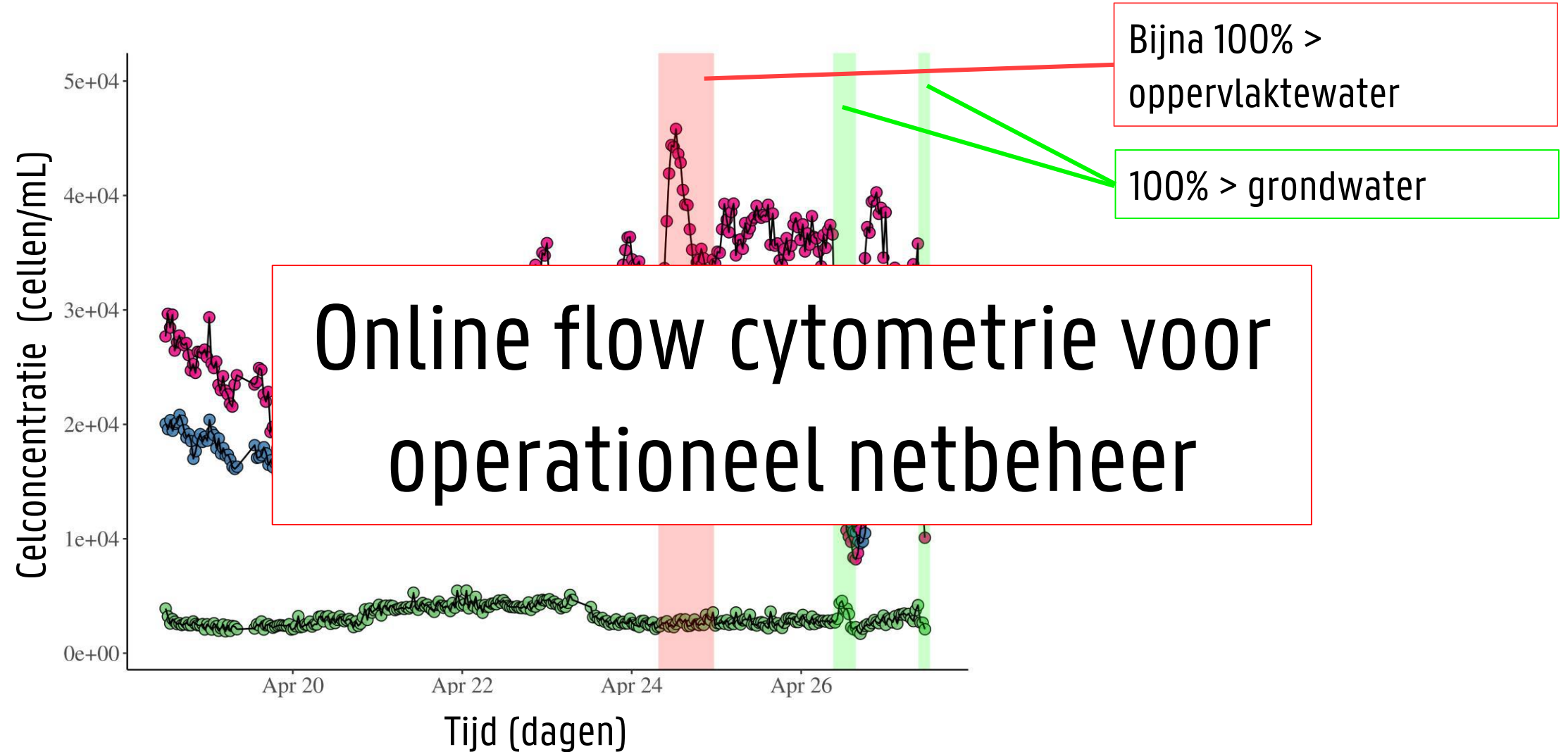

Conclusie en potentieel

- Waardevolle techniek voor drinkwatermonitoring
- Online monitoring microbiële waterkwaliteit
 - Operationeel beheer
 - Abnormale veranderingen detecteren en voorspellen
 - Early warning system

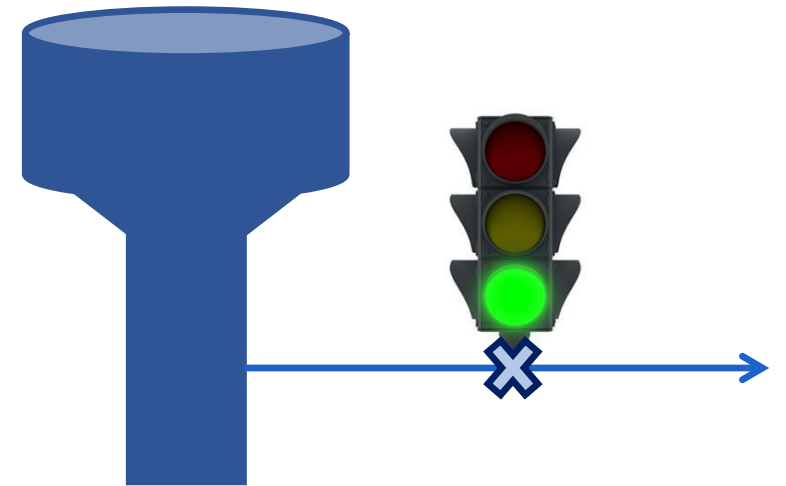



UNIVERSITEIT
GENT

Flow cytometric microbial monitoring for safeguarding drinking water quality

Ir. Jorien Favere

Promotors: Prof. Dr. Ir. Nico Boon & Prof. Dr. Ir. Bart De Gusseme

Tutors: Ir. Jasmine Heyse & Peter Rubbens



CMET

Center for Microbial Ecology and Technology

